

## Electric trolleys for INDUSTRIA 4 and 5 t

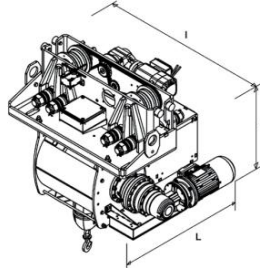

- Range of travel trolleys allowing the use of Huchez manufactured winches on jib cranes or rails of type IPE, IPN, HEB...
- Compatible winches: Industria range (4 and 5 T).
- Solution allowing to benefit of the maximum lifting heights of the winches.
- Motorized trolleys.

### Technical properties

- Single-speed electric trolleys.
- Power supply: 400V 50HZ three-phase.
- All our trolleys are equipped with an upper limit fork.
- Counterweight for cable included.
- Lifting and travel functions on the pendant control 3 meters control cable (contact us for other lengths).
- Optional travel limit switch.

### Technical characteristics of Electric trolleys for INDUSTRIA 4 and 5 t

References	IND5 E Trolley
Total weight (winch included)	1020 kg
Dimensions (L x w x h) mm	730 x 1100 x 1075
Lost height under beam in mm	1750
Beam width in mm	80-310
Trolley speed	6 m/min
Winch range	Industrial 4-5T

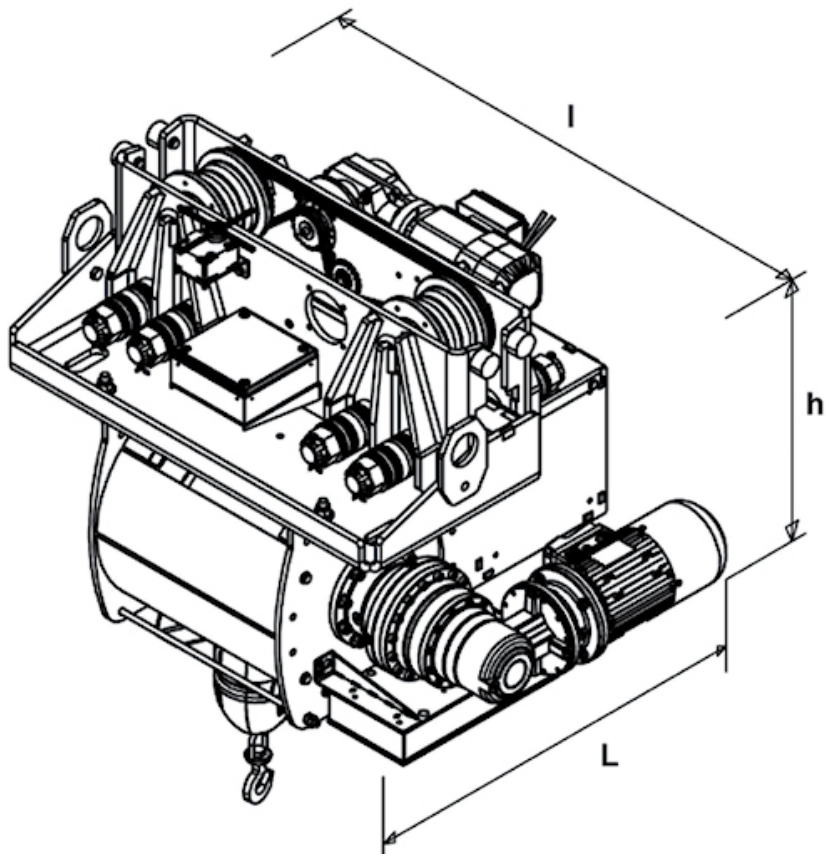

## Technical characteristics of the other models of the range

References	IND5 E Trolley	IND3 E Trolley
Total weight (winch included)	<b>1020 kg</b>	700 kg
Dimensions (L x w x h) mm	<b>730 x 1100 x 1075</b>	730 x 1100 x 910
Lost height under beam in mm	<b>1750</b>	1500
Beam width in mm	<b>80-310</b>	80-310
Trolley speed	<b>6 m/min</b>	6 m/min
Winch range	<b>Industrial 4-5T</b>	Industrial 2-3T



HUCHEZ  
4, rue Michel HAMMID  
60420 FERRIERES – France  
+33 (0) 3 44 51 11 33  
[www.huchez.com](http://www.huchez.com)  
[contact@huchez.fr](mailto:contact@huchez.fr)



SERVICE CLIENTS  
ATENCIO AL CLIENTE  
KUNDENSERVICE



Pour en savoir plus, n'hésitez pas à nous contacter!  
To know more, please contact us!  
Para más información, póngase en contacto con nosotros!  
Für weitere Informationen können Sie sich gerne an uns wenden!